

ROADM and Wavelength Selective Switches

Perspectives for Fiber Optic Manufacturing Test Engineering

With almost all new system deployments leveraging ROADM-based AON networks, Manufacturing Test and Component engineers are reviewing their needs and strategies for DWDM module testing—something they have not had to do for a long time.

Introduction

A critical enabler of the initial dense wavelength division multiplexing (DWDM) revolution was the arrival of new scalable manufacturing test solutions such as the VIAVI Swept Wavelength System (SWS) shown in Figure 1 that resolves the unique optical properties of the passive optical multiplexer, demultiplexer, and fixed wavelength add-drop modules fueling DWDM build-out. These DWDM components were unique due to their ability to isolate transmission signals on successively narrow wavelength grids (as tight as 50 GHz) without overly impacting system loss. This required components that had low “in-band” or “passband” loss and very high “out-of-band” loss or isolation. DWDM component manufacturing measurement systems needed to be able to resolve insertion losses as small as 0.05 dB, as high as 70 dB and with transition slopes as high as 100 dB/nm; all with less than 3 pm of wavelength resolution.

Today, Agile Optical Network (AON) technology is revolutionizing DWDM network architectures. Wavelength Selective Switches (WSS) are a critical enabler of Reconfigurable Optical Add-Drop Multiplexers (ROADMs)—the heart of these systems. Manufacturing test engineers across the supply chain are on the front lines of enabling this transition.

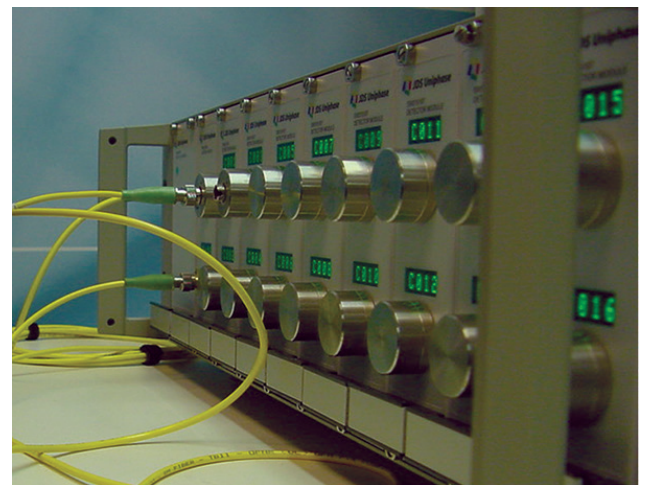

Figure 1. VIAVI SWS Test Station for DWDM Component and Module Measurements

ROADM and WSS Basics

The key difference between a fixed demultiplexer and a WSS is illustrated in Figure 2. For a demultiplexer, there is a clear, fixed relationship between output port and wavelength; each wavelength is assigned a specific output fiber (or port). By contrast with a WSS, any wavelength, group, or band of wavelengths can be directed to any output fiber. These output patterns may be changed or reassigned to different output fibers through an electrical interface. This dynamic capability has also expanded in most cases to include an attenuation function. While a demultiplexer is typically built from a few fixed optical elements, the 1x5 WSS shown in Figure 2 has the functional equivalency to an integrated module with one 80-channel demultiplexer, 80 variable optical attenuators (VOAs), 80 1x5 switches, and five 80-channel demultiplexers. Insertion loss for these next-generation modules can range between 2.5 and 8 dB, depending on the exact functionality and design.

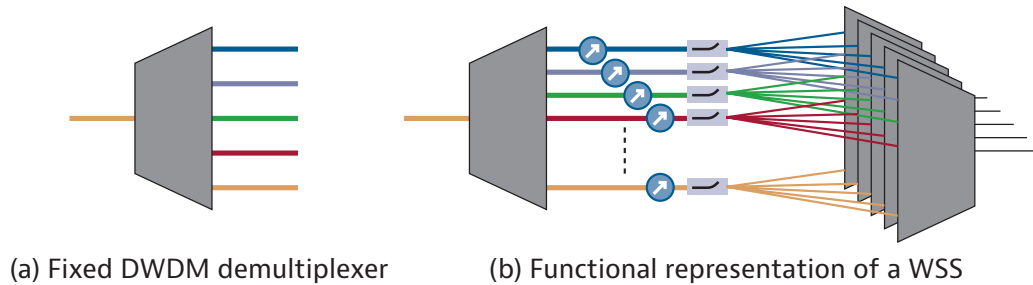

Figure 2. Functional difference between fixed DWDM demultiplexer and a WSS. The fixed demultiplexer (a) separates specific wavelengths to a fixed output fiber. The WSS (b) allows any wavelength to be mapped to any output fiber and is functionally equivalent to over 150 discrete components.

This integrated functionality enables many new optical network architectures. One of the most commonly discussed is the Degree-4 ROADM node. In Figure 3, four 1x5 WSSs are interconnected allowing any wavelength coming into the ROADM to be re-directed to any of the other three outgoing directions while also allowing local traffic to be added or dropped. One of the key optical consequences is the number of demultiplexing and multiplexing events as a signal traversing the node may experience. New critical performance and test tolerances are required on the WSS bandwidths.

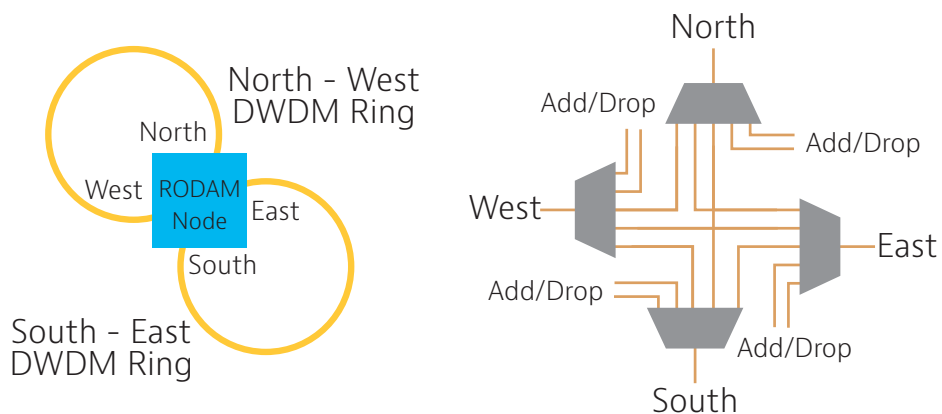

Figure 3. Degree-4 Node allows an input signal to be mapped to one or three output directions or be terminated through a local drop port at the node. The Degree-4 node enables the interconnection of two DWDM rings.

To complete the ROADM, amplification, channel monitoring, and even dispersion compensation may be added. The next section, reviews some of the critical measurement issues facing test engineers who manufacture, inspect, and integrate WSS technologies.

Initial Implications for the Test Engineer

The good news is that the basic measurement processes for fixed DWDM and agile WSS modules are generally the same. Industry-approved test methods are outlined in IEC 61300-3-29. This standard describes the basic metrology accepted by the industry for characterization of DWDM components as narrow as 25 GHz for both insertion loss and polarization-dependent loss.

However, as Table 1 shows, there are three major areas where the manufacturing engineer must understand the functional differences and develop test strategies to accommodate.

Functional Difference	Fixed Demultiplexer	Wavelength Selective Switch	Measurement Impact
Reconfigurable	None	1000 s states	<ul style="list-style-type: none"> • Additional testing to verify pattern dependencies • Testing to ensure stability and repeatability
Calibration	None	VOAs Wavelength mapping	Additional testing to set look-up tables and verification of accuracies
Architectural Impact	Point to point O/E/O	Rings Limited E/O Multiple cascaded	Verification and yield out due to tighter tolerances on channel drop, crosstalk, and bandwidth to ensure cascaded performance requirements

Table 1. Summary of differences between fixed demultiplexer and WSS

The most apparent challenge is the total number of test states that must be verified, either during manufacture or during design verification. While a fixed demultiplexer can be fully characterized in one to four measurements, the WSS can take hundreds, which puts a premium on rapid measurements. However, with the wavelength agility of each output port, potential for interactions between different ports as wavelength patterns are changed, so the speed of characterization over multiple output ports (typically between five and 40) across the entire C or C+L band must be optimized.

As shown in Figure 4, the test engineer must work with the design team or supplier to define test patterns and sequences that can be used to verify performance. It is not possible to test every conceivable state. Test patterns are chosen in order to stress the device. While each device and design will have different performance limitations, Figure 4 shows some of the most common patterns. The odd/even pattern configures the WSS as an interleaver, sending alternate wavelength slices to two different ports. In this configuration, channel uniformity, band shape, and crosstalk characteristics can be viewed. Although the pattern is simple, the number of port pair combinations can still create a number of test cases. In this pattern, it is also possible to verify VOA performance. The third pattern is the single drop, where one channel is isolated from the express path and routed to a different port. This configuration verifies the ability of the WSS to completely remove a channel and ensures minimal residual signal is present when or if the wavelength is added back into the system at a later node. This measurement is often called extinction ratio. The last pattern is the all-block and all-pass state, where base loss and flatness can be verified. Clearly there are many other patterns possible, and the test engineer must understand what patterns deliver the most information about their module.

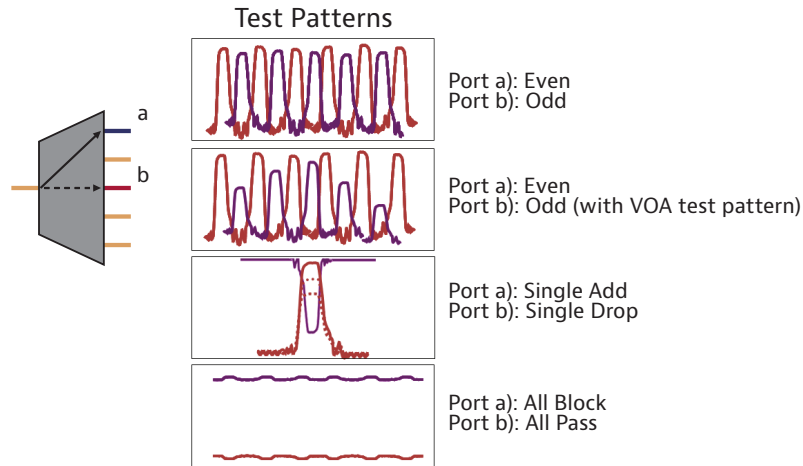

Figure 4. Example test patterns for a WSS showing some of the more challenging test states. These patterns can be replicated across many different channel pairs.

Given these test realities, test content will increase relative to fixed DWDM components. As a result, test strategies with scalable paths to cost-effectively grow test capacity are critical to developing a WSS test plan. Figure 5 shows examples of how to effectively grow test capacity. The first test plan uses systems or instruments with a centralized distributed architecture. These are instruments that allow multiple parallel tests to occur through distribution of the test signal to multiple measurement stations. Although one measurement station exists per module, the centralized test element is only purchased once. In addition, through the use of optical switching, multiple test devices can be connected to single measurement stations. This automation improves operational efficiency and capital utilization. It is possible to use both strategies together. Given the increase in test requirements, it is critical for test engineers to consider how to increase test capacity while keeping cost under control.

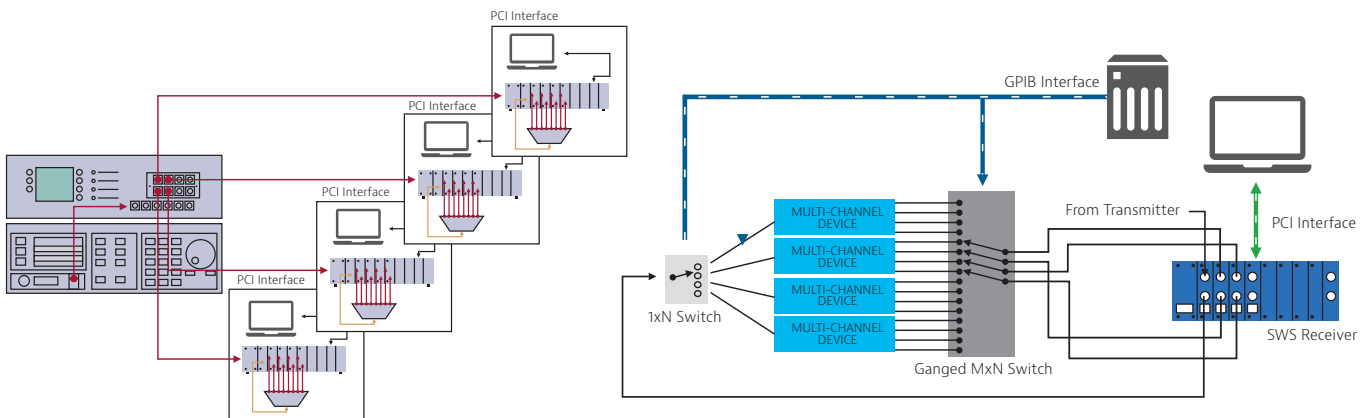

Figure 5. The unique distributed architecture of the VIAVI SWS test system enables the lowest cost of test while still maintaining the speed of measurement and scanning range required for ROADM components. Optical switches can improve capital utilization and increase the number of modules that can be tested at an individual station.

Loss and PDL Measurements

International standards such as IEC 61300-3-29 give guidance on the analysis of DWDM modules and can be extended to WSS modules. Figure 6 shows some of the key measurements to be extracted from three channels of a DWDM or WSS. The numbered bullets identify the critical parameters. In this figure, the device is shown in a mode where individual ITU channels are isolated and routed to individual output fibers. One of the unique WSS measurements is attenuation, shown in blue circle 1. This is a measurement of the increase in loss at the ITU channel wavelength with the setting of the in-line VOA.

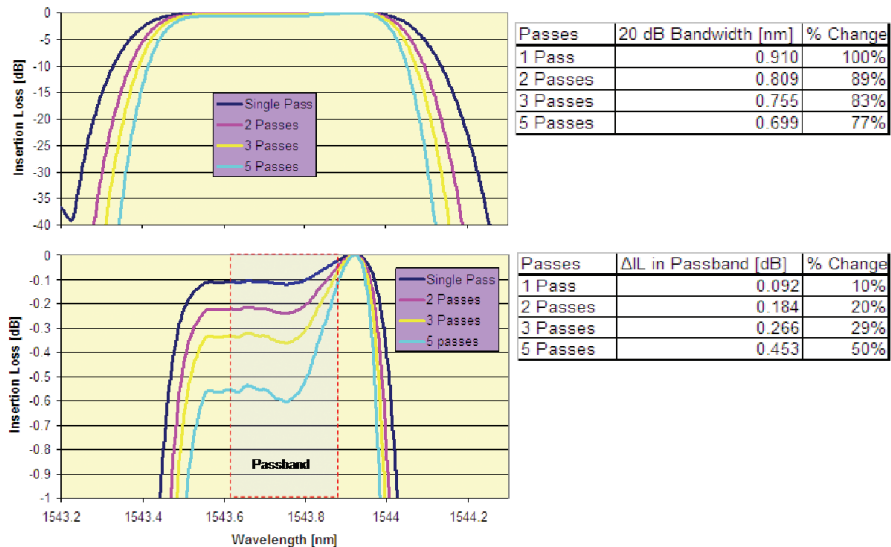

Figure 6. Basic analysis of multiple ports of a DWDM or WSS. Having acquired the loss vs. wavelength traces for three ports, key measurements can be extracted from the data, as highlighted by the key on the right.

ROADM Cascades and Measurement of Edge Effects

One of the key differences between a DWDM and a WSS is the need for the WSS to operate in cascaded configurations without O/E/O regeneration. Today's designers look at multiple ROADM architectures that require 10 or more WSSs in series. With multiple cascaded devices, the impact of filter edge effects become more pronounced due to bandwidth "thinning." As bandwidth narrows, the impact of edge effects from polarization dependent loss (PDL), group, and differential group delay become more pronounced and, therefore, difficult to manage. Ensuring tight measurement tolerance on bandwidth measurements requires test systems with precise wavelength tolerances and high dynamic range. While there is pressure to measure faster, wavelength sampling accuracy must remain extremely high.

Figure 7 demonstrates two of the key impacts of cascaded architectures. The upper graph shows up to five WSSs are measured in series. Note the decrease in the effective channel bandwidth, often referred to as bandwidth thinning. Note also that the data has been normalized to simplify comparison. In addition, zooming-in on the device passband the cascade impact is shown on the channel flatness. It is important to note that in the case of bandwidth thinning, this is likely not the worst-case example, as the same filter was traversed several times. Here the center wavelengths are precisely aligned. In the event that the WSS in the chain has wavelength offset, this effect can be even more dramatic. This offset impact is one of the driving reasons for ensuring tight tolerances on bandwidth, center wavelength, and ITU offset measurements. For the flatness, the opposite is true; this is likely a worst-case example. If the passband flatness structure is similar for all of the cascaded channels, the result is as shown. However, it is likely that there are some differences channel to channel, causing some averaging that minimizes the minimum to maximum difference.

Additionally, WSS measurement systems must resolve center wavelength and bandwidth changes as a state of polarization. In single-mode fiber, the polarization state is not controlled. It is likely that the transmission signal will be at a different polarization state as it traverses each WSS in a cascaded design. If the device has a strong center wavelength shift or bandwidth changes with polarization state, the bandwidth thinning effect discussed previously could become more pronounced.

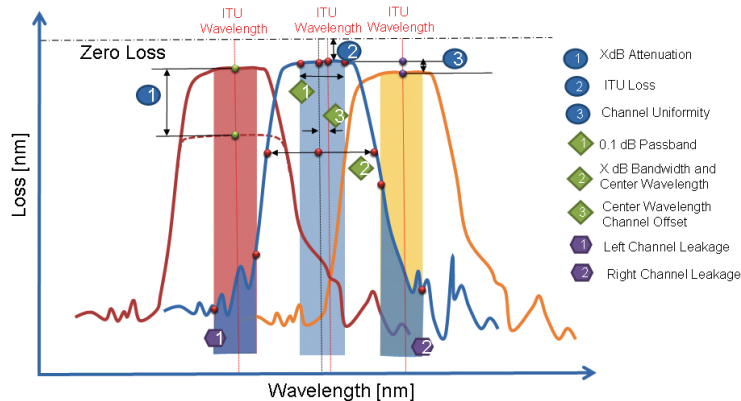

Figure 7. Filter shapes are impacted by multiple cascades. Bandwidth “thinning” and effective passband flatness are critical measurements that must be made.

Dispersions

Finally, it is important to note that concurrent with deployment of ROADM- and WSS-based Agile Optical Networks is the initial roll out of 40 Gbps. One particular challenge of 40 Gbps is the spread spectrum around the carrier. Figure 8 shows how a typical 40 Gbps NRZ signal fills a significant portion of the 100 GHz bandwidth channel. The criticality of this measurement has driven development of a new IEC standard IEC 61300-3-38, which is in final voting as of this writing. Group delay variation across the spectral bandwidth causes eye distortion and ultimately bit errors.

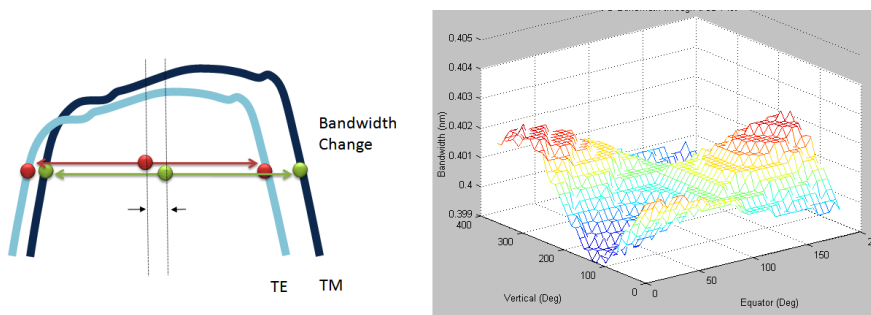

Figure 8. The graph on the left represents the filter shape impact for two orthogonal states for polarization. The WSS filter shape experiences center wavelength shifts and changes in the bandwidth. The graph on the right shows that the 3 dB

A WSS test strategy must include the ability to upgrade by adding GD and DGD measurements. As described previously, bandwidth thinning is a reality in cascaded architectures. Figure 9 shows how GD variation becomes most pronounced at the edges. As the cascade number increases, GD variation can creep more prominently into the passband.

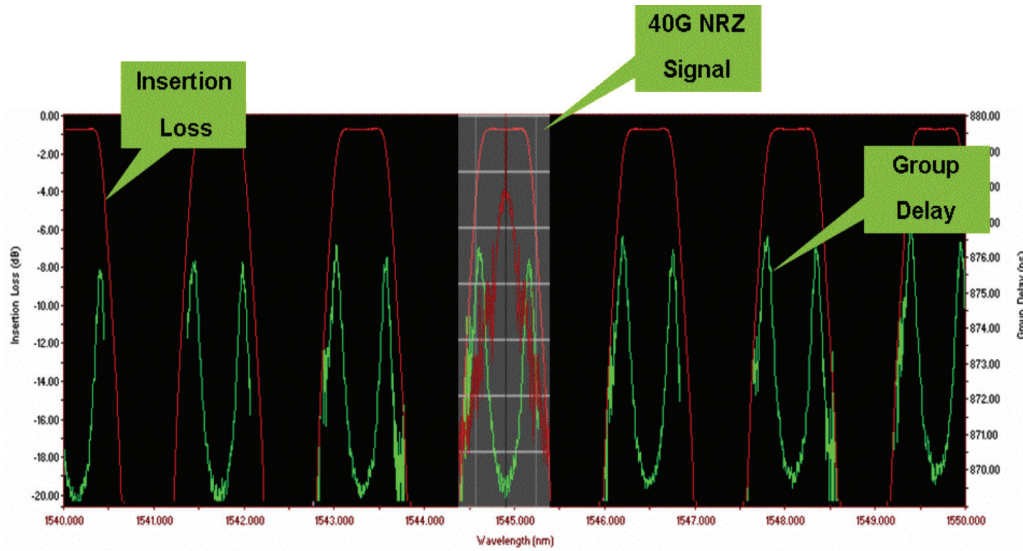

Figure 9. Measurement of insertion loss for an odd/even channel pattern with in-band group delay measurement. Chromatic Dispersion (CD) is derivative of group delay.

Summary

The key differences between fixed DWDM components and WSS have been reviewed. For the test engineer, this new class of components forces a re-evaluation of test equipment and test strategies. Accuracy, speed, number of test cases, and strategies for reducing the cost of test are all critical components of emerging test plans.

Table 2 lists some of the key criteria that should be considered when selecting test and measurement devices.

Key Measurement Requirements

- Measures between 5 and 40 WSS ports in parallel
- Provides speed of measurement over full C band or C+L band
- Maintains wavelength accuracy at full scan speed
- Supports PDL and advanced polarization analysis
- Provides GD and DGD measurement capability
- Balances cost-effectiveness as test cases increase
- Provides tools for the evaluation of bandwidth effects

Table 2. Key measurement requirements for WSS