



3550/3550R

Communications Test Set

Getting Started Manual





3550 / 3550R

Communications Test Set

Getting Started Manual

PUBLISHED BY VIAVI Solutions, Inc.

COPYRIGHT © 2020 VIAVI Solutions, Inc.

All rights reserved. No part of this publication may be reproduced, stored in a retrieval system, or transmitted in any form or by any means, electronic, mechanical, photocopying, recording or otherwise without the prior permission of the publisher.

Re-Issued

Feb 2020

10200 West York / Wichita, Kansas 67215 U.S.A. / (316) 522-4981 / FAX (316) 524-2623

Subject to Export Control, see Cover Page for details.

This manual contains essential information relating to initial use of the Unit. VIAVI recommends the operator become familiar with the Operation Manual contained on the accompanying CD-ROM.

VIAVI updates Test Set software on a routine basis. As a result, examples may show images from earlier software versions. Images are updated when appropriate.

Product Warranty

Refer to <https://www.viavisolutions.com/en-us/support/warranty-quality-compliance-policies> for product warranty information.

Electromagnetic Compatibility

Double shielded and properly terminated external interface cables must be used with this equipment when interfacing with the REMOTE Connector.

For continued EMC compliance, all external cables must be shielded and 3 meters or less in length.

Nomenclature Statement

In this manual, 3550 / 3550R, Test Set or Unit refers to the 3550 / 3550R Communications Test Set.

Declaration of Conformity

The Declaration of Conformity Certificate included with the Unit should remain with the Unit.

VIAVI recommends the operator reproduce a copy of the Declaration of Conformity Certificate to be stored with the Operation Manual for future reference.

Software Version

VIAVI updates Test Set software on a routine basis. As a result, examples may show images from earlier software versions. Images are updated when appropriate.

Power Cords

The AC Power Cord included with the unit, or an appropriate replacement, should be used to connect the Test Set to a grounded AC power supply. Failure to ground the Test Set may expose the operator to hazardous voltage levels.

To connect the Test Set to a Class II (ungrounded) 2-terminal socket outlet, fit the power cord with either a 3-pin Class I plug used in conjunction with an adapter incorporating a ground wire, or fit the power cord with a Class II plug containing an integral ground wire. The ground wire must be securely fastened to ground; grounding one terminal on a 2-terminal socket does not provide adequate protection.

Power cords must be in good operating condition. Power cords must not be frayed or broken, nor expose bare wiring. Using a damaged power cord may expose the operator to hazardous voltage levels.

International Power Requirements

The AC power cord must meet local regulations and power requirements. Check with local standards and regulations to ensure the power cord being used meets all local safety regulations.

Precautions

SAFETY FIRST - TO ALL OPERATIONS PERSONNEL

General Conditions of Use

This product is designed and tested to comply with the requirements of IEC/EN61010-1 'Safety requirements for electrical equipment for measurement, control and laboratory use' for Class I portable equipment and is for use in a pollution degree 2 environment. The equipment is designed to operate from installation supply Category II.

The 3550 should be protected from liquids such as spills, leaks, etc. and precipitation such as rain, snow, etc. The 3550R is ruggedized and can tolerate spills, leaks, rain, snow, etc. When moving the equipment from a cold to hot environment, allow the temperature of the equipment to stabilize before the Unit is connected to an AC power supply to avoid condensation forming. The equipment must only be operated within the environmental conditions specified in the product specifications.

This product is not approved for use in hazardous atmospheres or medical applications. If the equipment is to be used in a safety-related application, such as avionics or military applications, the suitability of the product must be assessed and approved for use by a competent person. Refer all servicing of Unit to Qualified Technical Personnel.

WARNING





PROTECTION PROVIDED BY EQUIPMENT MAY BE IMPAIRED IF THE TEST SET IS USED IN A MANNER NOT SPECIFIED BY THE MANUFACTURER.

Safety Identification in Technical Manual

This manual uses the following terms to draw attention to possible safety hazards that may exist when operating or servicing this equipment:

CAUTION	IDENTIFIES CONDITIONS OR ACTIVITIES THAT, IF IGNORED, CAN RESULT IN EQUIPMENT OR PROPERTY DAMAGE, E.G. FIRE.
WARNING	IDENTIFIES CONDITIONS OR ACTIVITIES THAT, IF IGNORED, CAN RESULT IN PERSONAL INJURY OR DEATH.

Safety Symbols in Manuals and on Units

	CAUTION: Refer to accompanying documents. (Symbol refers to specific CAUTIONS represented on the Unit and clarified in the text.)
	Indicates a Toxic hazard.
	Indicates item is static sensitive.
	AC TERMINAL: Terminal that may supply or be supplied with AC or alternating voltage.
	Indicates a fuse (AC or DC).

Case, Cover or Panel Removal

WARNING **CAUTION**

Opening the Case Assembly exposes the operator to electrical hazards that may result in electrical shock or equipment damage. Do not operate this Test Set with the Case Assembly open.

Equipment Grounding Protection

WARNING **CAUTION**

Improper grounding of equipment can result in electrical shock.

Use of Probes

WARNING **CAUTION**

Refer to Performance Specifications for the maximum voltage, current and power ratings of any connector on the Test Set before using the connector with a probe from a terminal device. To prevent electrical shock or damage to the equipment verify the terminal device performs within noted specifications before using it for measurements.

DMM Measurement Category

The Digital Multimeter (DMM) is classified in Measurement Category II. Measurement Category II is designated for equipment which performs measurements on circuits directly connected to low voltage installation.

Power Cords

The AC Power Cord included with the unit, or an appropriate replacement, should be used to connect the Test Set to a grounded AC power supply. Failure to ground the Test Set may expose the operator to hazardous voltage levels.

To connect the Test Set to a Class II (ungrounded) 2-terminal socket outlet, fit the power cord with either a 3-pin Class I plug used in conjunction with an adapter incorporating a ground wire, or fit the power cord with a Class II plug containing an integral ground wire. The ground wire must be securely fastened to ground; grounding one terminal on a 2-terminal socket does not provide adequate protection. Power cords must be in good operating condition. Power cords must not be frayed or broken, nor expose bare wiring. Using a damaged power cord may expose the operator to hazardous voltage levels.

International Power Requirements

The AC power cord must meet local regulations and power requirements. Check with local standards and regulations to ensure the power cord being used meets all local safety regulations.

Use Recommended Fuses Only

Use only fuses specifically recommended for the equipment at the specified current and voltage ratings. Refer to Performance Specifications for fuse requirements and specifications.

Internal Battery

This Unit contains a Lithium Ion Battery, serviceable only by a qualified technician.

EMI (Electromagnetic Interference)

CAUTION

SIGNAL GENERATORS CAN BE A SOURCE OF ELECTROMAGNETIC INTERFERENCE (EMI) TO COMMUNICATION RECEIVERS. SOME TRANSMITTED SIGNALS CAN CAUSE DISRUPTION AND INTERFERENCE TO COMMUNICATION SERVICE OUT TO A DISTANCE OF SEVERAL MILES. USER OF THIS EQUIPMENT SHOULD SCRUTINIZE ANY OPERATION THAT RESULTS IN RADIATION OF A SIGNAL (DIRECTLY OR INDIRECTLY) AND SHOULD TAKE NECESSARY PRECAUTIONS TO AVOID POTENTIAL COMMUNICATION INTERFERENCE PROBLEMS.

Input Overload

CAUTION

REFER TO PRODUCT SPECIFICATIONS FOR MAXIMUM INPUT RATINGS FOR ANT AND T/R INPUT CONNECTORS.

Fire Hazards

WARNING

MAKE SURE THAT ONLY FUSES OF THE CORRECT RATING AND TYPE ARE USED FOR REPLACEMENT. IF AN INTEGRALLY FUSED PLUG IS USED ON THE SUPPLY LEAD, ENSURE THAT THE FUSE RATING IS COMMENSURATE WITH THE CURRENT REQUIREMENTS OF THIS EQUIPMENT.

Toxic Hazards

WARNING

SOME OF THE COMPONENTS USED IN THIS EQUIPMENT MAY INCLUDE RESINS AND OTHER MATERIALS WHICH GIVE OFF TOXIC FUMES IF INCINERATED. TAKE APPROPRIATE PRECAUTIONS IN THE DISPOSAL OF THESE ITEMS.

Toxic Hazards (cont)

**BERYLLIA****WARNING**

BERYLLIA (BERYLLIUM OXIDE) IS USED IN THE CONSTRUCTION OF SOME OF THE COMPONENTS IN THIS EQUIPMENT.

THIS MATERIAL, WHEN IN THE FORM OF FINE DUST OR VAPOR AND INHALED INTO THE LUNGS, CAN CAUSE A RESPIRATORY DISEASE. IN ITS SOLID FORM, AS USED HERE, IT CAN BE HANDLED SAFELY, HOWEVER, AVOID HANDLING CONDITIONS WHICH PROMOTE DUST FORMATION BY SURFACE ABRASION.

USE CARE WHEN REMOVING AND DISPOSING OF THESE COMPONENTS. DO NOT PUT THEM IN THE GENERAL INDUSTRIAL OR DOMESTIC WASTE OR DISPATCH THEM BY POST. THEY SHOULD BE SEPARATELY AND SECURELY PACKED AND CLEARLY IDENTIFIED TO SHOW THE NATURE OF THE HAZARD AND THEN DISPOSED OF IN A SAFE MANNER BY AN AUTHORIZED TOXIC WASTE CONTRACTOR.

**BERYLLIUM COPPER****WARNING**

SOME MECHANICAL COMPONENTS WITHIN THIS INSTRUMENT ARE MANUFACTURED FROM BERYLLIUM COPPER. THIS IS AN ALLOY WITH A BERYLLIUM CONTENT OF APPROXIMATELY 5%. IT REPRESENTS NO RISK IN NORMAL USE.

THE MATERIAL SHOULD NOT BE MACHINED, WELDED OR SUBJECTED TO ANY PROCESS WHERE HEAT IS INVOLVED. IT MUST BE DISPOSED OF AS "SPECIAL WASTE."

IT MUST NOT BE DISPOSED OF BY INCINERATION.

Toxic Hazards (cont)

**LITHIUM****WARNING**

A LITHIUM BATTERY IS USED IN THIS EQUIPMENT.

LITHIUM IS A TOXIC SUBSTANCE SO THE BATTERY SHOULD IN NO CIRCUMSTANCES BE CRUSHED, INCINERATED OR DISPOSED OF IN NORMAL WASTE.

DO NOT ATTEMPT TO RECHARGE THIS TYPE OF BATTERY OUTSIDE OF THE TEST SET. DO NOT SHORT CIRCUIT OR FORCE DISCHARGE SINCE THIS MIGHT CAUSE THE BATTERY TO VENT, OVERHEAT OR EXPLODE.

Static Sensitive Components



This equipment contains components sensitive to damage by Electrostatic Discharge (ESD). All personnel performing maintenance or calibration procedures should have knowledge of accepted ESD practices and/or be ESD certified.

Table of Contents

Service Upon Receipt of Material	8
Specifications	13
Installation	15
External Cleaning.....	18
Controls, Connectors and Indicators.....	18
Power On/Off Procedures.....	21
Touch Screen	22
Multi-Language Support	22
User Interface (UI) Components.....	23
Defining Parameters.....	25
Suspend (Sleep) Mode.....	27
System Menu.....	28
Configuration Modes	29
Screen Hierarchy	30
Battery/Fuse Replacement	31

1.0 SERVICE UPON RECEIPT OF MATERIAL

1.1 Unpacking

Use the following steps to unpack the Test Set:

STEP	PROCEDURE
------	-----------

1. Cut and remove sealing tape on top of shipping container.
2. Open shipping container and remove Transit Case.
3. Place Transit Case on a clean and dry surface.
4. Open Transit Case to inspect contents.
5. Store shipping container for possible future use.

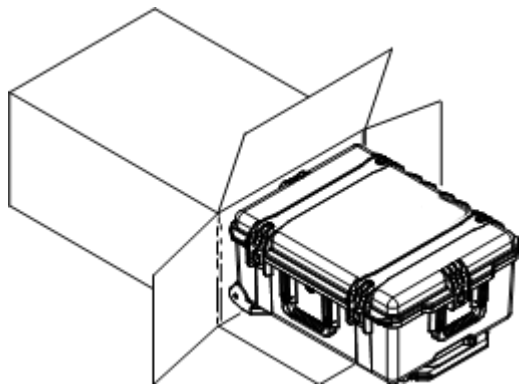

1.2 CHECKING UNPACKED EQUIPMENT

Check the equipment for damage incurred during shipment. If the equipment has been damaged or if items seem to be absent from the shipment, report the damage and/or discrepancies to VIAVI Customer Service.

Contact:

VIAVI

Attn: Customer Service

10200 West York Street

Wichita, Kansas 67215

Telephone: (800) 835-2350 (U.S. only)

(316) 522-4981

FAX: (316) 524-2623

email: AvComm.Service@viasolutions.com





Standard Items





DESCRIPTION	PART NUMBER	QTY
3550 / 3550R		
Adapter (BNC-F to TNC-M)*	23758	5
Antenna (BNC) (50 MHz) (HF)*	9149	1
Antenna (BNC) (150 MHz) (VHF)*	9145	1
Antenna (BNC) (450 MHz) (UHF)*	9147	1
Antenna (BNC) (800 MHz)*	9143	1
Cable (BNC) (M-M) (48 in)*	62368	2
Cable (TNC) (M-M) (48 in)*	62398	1
Case, Accessory*	5762	1
Case, Transit*	91706	1
Cover / Stand*	91679	1
External DC Power Supply	67374	1
Fuse, Spare (5 A, 32 Vdc, Type F)*	56080	2
Handset*	64606	1
Manual, Getting Started (Paper) (English)	90521	1
Manual, Operation (CD) (English)	90520	1
Power Cable (AC) (3-wire leads)*	27516	1

DESCRIPTION	PART NUMBER	QTY
Power Cable (AC) (China)*	91803	1
Power Cable (AC) (Continental Europe)*	27480	1
Power Cable (AC) (North America)*	27478	1
Power Cable (AC) (UK)*	27477	1
Power Cable (AC) (DC Cigarette Lighter)*	62404	1
Short-Open-Load VSWR Calibrator (TNC)*	38245	1

* Included with Regional Accessory Kit (U.S., International or China)





Subject to Export Control, see Cover Page for details.

3550 / 3550R	Adapter (BNC-F to TNC-M)	Antenna (BNC) (50 MHz) (HF)	Antenna (BNC) (150 MHz) (VHF)
	23758	9149	9145
			





Antenna (BNC) (450 MHz) (UHF)	Antenna (BNC) (800 MHz)	Cable (BNC) (M-M) (48 in)	Cable (TNC) (M-M) (48 in)
9147	9143	62368	62398
			

Subject to Export Control, see Cover Page for details.

Case, Accessory	Case, Transit	Cover / Stand	External DC Power Supply
5762	91706	91679	67374
			

Fuse, Spare (5 A, 32 Vdc, Type F)	Handset	Manual, Getting Started (Paper) (English)	Manual, Operation (CD) (English)
56080	64606	90521	90520
			

Subject to Export Control, see Cover Page for details.

Power Cable (AC) (3-wire leads)	Power Cable (AC) (China)	Power Cable (AC) (Continental Europe)	Power Cable (AC) (North America)
27516	91803	27480	27478
			

Power Cable (AC) (UK)	Power Cable (DC Cigarette Lighter)	Short-Open-Load VSWR Calibrator (TNC)
27477	62404	38245
		 (or) 

Subject to Export Control, see Cover Page for details.

2.0 SPECIFICATIONS

(Specifications are subject to change without notice.)

ENVIRONMENTAL / PHYSICAL

Overall Dimensions

231 mm (W), 285 mm (L), 70 mm (D)
(9.1 in X 11.2 in X 2.8 in)

Weight

8.3 lbs. (3.75 kg); 12 lbs. (5.4 kg) with accessories

Temperature (Storage)

-51°C to +71°C

Battery must not be subjected to temperatures below
-20°C, nor above +60°C

Temperature (Operation)

DC Only (battery removed, contingent upon applied
RF power over time*)

0°C to +50°C (3550)

-20°C to +55°C (3550R)

Battery (typical based on internal temperature rise and
usage of the instrument*)

0°C to +40°C (3550)

-20°C to +40°C (3550R)

Battery is to be charged at temperatures between 0°C
and +45°C only.

Altitude

4600 M

Humidity

95% maximum (non-condensing)

Shock, Functional

30 G

Vibration

MIL-PRF-28800F, Class 3 (3550)

MIL-PRF-28800F, Class 2 (3550R)

Water (3550R only)

Blowing Rain, Drip Proof and Salt Exposure; Enclosure

Dust Resistance

MIL-PRF-28800F, Class 2

Solar Radiation

MIL-PRF-28800F, Class 2 (3550R)

*Use reason when working with RF test instruments. All thermal ratings are dependent upon applied RF power. The 3550 alarms once the internal temperature of the 3550 exceeds predetermined limits. Applying power continuously in high ambient temperature conditions result in a heat build-up within the instrument. The 3550 is rated for 20 W (43 dBm) for 10 minutes at +25°C or until thermal alarm sounds. Exceeding these conditions results in thermal shutdown.

Subject to Export Control, see Cover Page for details.

COMPLIANCE / SAFETY

EMC

Emissions

MIL-PRF-28800F
EN61326: 1998 Class A
EN61000-3-2
EN61000-3-3

Immunity

MIL-PRF-28800F
EN61326: 1998

Safety

UL 61010-1
UL 6101-1
CSA

AC INPUT POWER (AC to DC Converter/Charger Unit)

AC Input Voltage Range

100 to 240 VAC, 1.5 A maximum, 47 Hz to 63 Hz

Operating Temperature

0°C to +40°C

Storage Temperature

-20°C to +85°C

EMI

EN55022 Class B
EN61000-3-2 Class D

Safety

UL 1950, CSA 22.2 No. 234 and No. 950, IEC 950/
EN 60950

DC INPUT POWER

DC Input Voltage Range (DC INPUT Connector)

11 to 32 Vdc

DC Power Input, Maximum (DC INPUT Connector)

55 W

DC Power Input, Nominal (DC INPUT Connector)

25 W

DC Fuse Requirement (DC INPUT Connector)

5 A, 32 Vdc, Type F

BATTERY

Battery Type

Lithium Ion (Li Ion) Battery pack

Battery must not be subjected to temperatures below
-20°C, nor above +60°C

Operation Time (Typical) (Duty Cycle: 80% Transmitter and 20% Receiver tests)

4.5 hours continuous use (Minimum Backlight) (Still Viewable)

4 hours continuous use (40% Backlight)

3.5 hours continuous use (100% Backlight)

Charge Time

4 hours (Unit OFF) / 8 hours (Unit ON)

Battery is to be charged at temperatures between
0°C and +45°C only.

3.0 INSTALLATION

The External DC Power Supply should only be connected to a grounded AC supply outlet.

3.1 Safety Precautions

The following safety precautions must be observed during installation and operation. VIAVI assumes no liability for failure to comply with any safety precaution outlined in this manual.

3.1.A Complying with Instructions

Installation/operating personnel should not attempt to install or operate the Test Set without reading and complying with instructions contained in this manual. All procedures contained in this manual must be performed in exact sequence and manner described.

3.1.B AC Power Requirements

The External DC Power Supply, supplied with the 3550 / 3550R, operates over a voltage range of 100 to 240 VAC at 47 to 63 Hz.

3.1.C Grounding Power Cord

Use a 3-prong AC Power Cord to connect the Test Set to a grounded AC Power Supply.

WARNING

DO NOT USE A THREE-PRONG TO TWO-PRONG ADAPTER PLUG. DOING SO CREATES A SHOCK HAZARD BETWEEN THE CHASSIS AND ELECTRICAL GROUND.

For AC operation, the AC Line Cable, connected to the External DC Power Supply, is equipped with a standard three-prong plug and must be connected to a properly grounded three-prong receptacle.

It is the customer's responsibility to:

- Have a qualified electrician check receptacle(s) for proper grounding.
- Replace any standard two-prong receptacle(s) with properly grounded three-prong receptacle(s).

3.1.D Operating Safety

WARNING

Due to potential for electrical shock within the Test Set, the Case Assembly must be closed when the Test Set is connected to an external power source.

Battery replacement, fuse replacement and internal adjustments must only be performed by qualified service technicians.

3.2 Battery

The 3550 / 3550R is powered by an internal Lithium Ion battery pack. The 3550 / 3550R is supplied with an External DC Power Supply which allows the operator to recharge the battery using AC power.

NOTE

The 3550 / 3550R can operate continuously on AC power via the External DC Power Supply, for servicing and/or bench tests.

3.2.A Battery Operation

The internal battery is equipped to power the 3550 / 3550R for 4.5 hours of continuous use, after which time, the 3550 / 3550R battery needs recharging. When the POWER Indicator is GREEN, the battery is at >25% capacity. When the POWER Indicator is YELLOW, the battery is at <25% capacity.

If the battery level, shown in the BAT Field on most Test Screens, drops to 10 (10%), the 3550 / 3550R powers down automatically.

3.2.B Battery Charging

The battery charger operates whenever the supplied External DC Power Supply or a suitable (11 to 32 Vdc) DC Power source is applied to the 3550 / 3550R. When charging, the battery reaches a 100% charge in approximately four hours (Unit OFF) / eight hours (Unit ON). The internal battery charger allows the battery to charge between a temperature range of 0° to 45°C.

The battery should be charged every three months (minimum) or disconnected for long term inactive storage periods of more than six months. The Battery must be removed when conditions surrounding the Test Set are <-20°C or >60°C.

Allow 20 minutes for the battery to charge when turning the 3550 / 3550R ON from a dead battery condition.

Use a 3-prong AC Power Cord to connect the Test Set to a grounded AC Power Supply.

3.2.C Battery Recharging (using the supplied External DC Power Supply)

- | STEP | PROCEDURE |
|------|--|
| 1. | Connect the External DC Power Supply to the DC IN Connector on the 3550 / 3550R. |
| 2. | Connect the AC Power Cable to the AC PWR Connector on the External DC Power Supply and an appropriate AC power source. |
| 3. | Verify the BATT Indicator is yellow. |
| 4. | Allow four hours (unit OFF) / eight hours (Unit ON) for battery charge or until the BATT Indicator is green. |

NOTE

If the BATT Indicator is yellow and/or the battery fails to accept a charge and the 3550 / 3550R does not operate on battery power, the battery, serviceable only by a qualified technician, requires replacement.



Subject to Export Control, see Cover Page for details.

4.0 EXTERNAL CLEANING

This section contains routine instructions for cleaning the outside of the Test Set.

CAUTION

**DISCONNECT POWER FROM TEST SET
TO AVOID POSSIBLE DAMAGE TO
ELECTRONIC CIRCUITS.**

- Clean front panel buttons with soft lint-free cloth. If dirt is difficult to remove, dampen cloth with water and a mild liquid detergent.
- Clean Front Panel display with soft lint-free cloth dampened (not soaked) with non-ammonia based glass cleaner.
- Remove grease, fungus and ground-in dirt from surfaces with soft lint-free cloth dampened (not soaked) with isopropyl alcohol.
- Remove dust and dirt from connectors with soft-bristled brush.
- Cover connectors, not in use, with suitable dust cover to prevent tarnishing of connector contacts.
- Clean cables with soft lint-free cloth.
- Paint exposed metal surface to avoid corrosion.

5.0 CONTROLS, CONNECTORS AND INDICATORS

5.1 Front Panel Controls, Connectors and Indicators

Refer to Numerical Reference Charts for connector cross-reference. Controls, Connectors and Indicators are listed by numerical reference.



Subject to Export Control, see Cover Page for details.

5.1 Front Panel Controls, Connectors and Indicators (cont)

#	Name	Description
1	Touch Screen Display	Used for viewing menus and screens and for providing manual input for data and settings.
2	DVM Connector	Provides DC coupled input for the Audio Level Meter and the Oscilloscope (Option) functions.
3	AUDIO IN Connector	Used to receive external modulation input, and as input for the SINAD and Distortion Meters and AF Counter.
4	AUDIO OUT Connector	Used as output for Demod and Function Generators and for Audio In signal output.
5	USB Connector	Allows allows connection of USB 1.1 devices (e.g. USB memory stick).
6	HOME Key	Provides access to a screen for the selection of optional system controls and settings.
7	POWER Key	Used for powering the 3550 / 3550R ON and OFF.

#	Name	Description
8	SYS Indicator	Illuminates when external DC power is applied. WHITE 3550 / 3550R is in "awake" mode. BLUE 3550 / 3550R is in "sleep" mode. RED 3550 / 3550R is shutting down.
9	BATT Indicator	Illuminates when external DC power is applied: GREEN Battery at Full Charge YELLOW Battery is Charging

Subject to Export Control, see Cover Page for details.

5.2 Test Set (Top) Connectors

Refer to Numerical Reference Charts for connector cross-reference. Connectors are listed by numerical reference.



#	Name	Description
7	ETHERNET Connector	Used for software upgrades and/or Remote Operation.

#	Name	Description
1	ANT Connector	Used for over-the-air tests.
2	T/R Connector	Used for high power direct connection to radio equipment.
3	DC IN Connector	Used for External DC operation of the 3550 / 3550R or battery charging.
4	AUDIO Connector	Used for connection to the Handset (Microphone and Speaker).
5	SWR Connector	Used for measuring the VSWR of Antenna systems. Also used as a transmit signal output.
6	REMOTE Connector	Used for communicating with external equipment.

Subject to Export Control, see Cover Page for details.

6.0 POWER ON/OFF PROCEDURES

6.1 Power ON Test Set

<u>STEP</u>	<u>PROCEDURE</u>
-------------	------------------

- | | |
|----|---|
| 1. | Press POWER Key to power on the Test Set. |
| 2. | Verify SYS Indicator illuminates. |
| 3. | Wait while Test Set completes power-up procedure. |

6.2 Power OFF Test Set

<u>STEP</u>	<u>PROCEDURE</u>
-------------	------------------

- | | |
|----|--|
| 1. | Press POWER Key to power off the Test Set. |
| 2. | Verify SYS Indicator is not illuminated. |

7.0 TOUCH SCREEN

7.1 3550

The 3550 contains a capacitive Touch Screen that is responsive to the touch of a human finger. The “touch” on the Touch Screen relies on the natural capacitance of the human body so no barriers to the skin (e.g. gloves) should be used.

If the 3550 is running on battery power only, the 3550 must be electrically grounded in order to allow the capacitance Touch Screen to function. Operators should keep both feet on the floor and one hand on the 3550 Case when using the Touch Screen.

7.2 3550R

The 3550R contains a resistive Touch Screen that is responsive to the touch of a human finger. Gloves can be worn when utilizing the Touch Screen or a writing instrument (e.g. stylus) can be used on the Touch Screen.

8.0 MULTI-LANGUAGE SUPPORT

The 3550 / 3550R can be configured to display the functions tiles, tabs and screens in several different languages (if purchased).



To change the 3550 / 3550R to a different language, select the System function tab. Select the desired language from the languages shown in the dropdown items.

9.0 USER INTERFACE (UI) COMPONENTS

The Test Set UI is a touch screen control panel that provides a flexible working environment for all users. The UI is designed to allow users to open and close, drag and drop, and maximize/minimize screen components to create custom display configurations.

The Test Set UI is navigated locally using the Front Panel Touch Screen.

The 3550 contains a resistive display. All operators must place one hand on the Test Set to ground the Test Set prior to utilizing the function tiles.

9.1 Launch Bar

The Launch Bar is a horizontal scrolling menu located at the top of the UI. The Launch Bar provides access to the Function Icons.

The Launch Bar is opened and closed by touching or clicking on the light gray bar at the bottom of the menu.



The Launch Bar is moved from left to right by “dragging” the launch bar or by pressing the left or right arrows.

9.2 Function Icons

The Launch Bar consists of icons that identify functions installed in the Test Set. The Function Icons displayed depend on the options installed in the Test Set.

Pressing a Function Icon opens the Function Window on the UI or brings an opened Function Window to the forefront of the UI.

9.3 Function Windows

Function Windows provide visual access to the Test Set's operating parameters and measurement data.

9.3.A Open/Close Function Windows

Function Windows are opened by selecting the Function Icon from the Launch Bar. Function Windows are closed by selecting the Minimize icon at the bottom of the Function Window.

9.3.B Function Window Viewing States

Standard View

Standard view occupies a pre-defined portion of the display. When in Standard View windows can be moved anywhere on the display area.

Full Screen View

When a Function Window is maximized, the window occupies the full display area and provides access to function parameters which may not be visible when a window is in Standard view.

Minimized

Function Windows can be minimized to the Launch Bar where they remain active but not visible on the display.

9.3.C Move Function Windows

Function Windows can be moved anywhere on the display area. To move a window, touch or click on the Function Window's title block or background and drag the window to a new location on the display.

Multiple screen functions can be displayed on the screen at any one time.

9.3.D Function Window Positioning

When Function Windows are opened they are positioned from left to right in unoccupied display space in the order in which they are opened. When the display is filled, Function Windows are opened and positioned in the center of the display on top of open windows.

When an active Function Window is closed and reopened, the Test Set positions the Function Window in the last active state and position on the display.

9.3.E Screen Icons



Minimize Mode - Press Button to display screen icons.











Press Open/Close icon to display screen icons with input window.



Subject to Export Control, see Cover Page for details.

9.3.F Screen Icon Descriptions

Icon	Description
	Opens and closes the Status Bar.
	Applies the external reference (Freq-Flex) Calibration value (if calibrated).
	Opens the Snapshot Function Window.
	Indicates touch screen functions are locked or unlocked.
	Captures (freezes) the readings/traces on the screen.
	Indicates Unit is controlled remotely.
	Displays Warnings and Error Messages.
	Displays the level of charge remaining in the Battery.
	Status window.

10.0 DEFINING PARAMETERS

Test Set parameters are defined using the following:

10.1 Numeric Entry Window

The Numeric Entry Window is displayed when a numeric data field is selected for editing. The Numeric Entry Window contains a Numeric Keypad, a Slider Bar and a Spinner Knob.

The type of numeric entry tool being displayed is changed by pressing the “flip” icon in the bottom right corner of the window. The window defaults to display the Numeric Keypad when it is opened.

10.1.A Numeric Keypad

The Numeric Keypad allows the user to enter a specific numeric value. Values are enabled by selecting a unit of measurement.



10.1.A Slider Bar

The Slider Bar allows the user to select and change a range of values. The value range is selected using the x10 and /10 buttons. The selected values are changed by dragging the slider bar left or right or by using the up/down arrows.

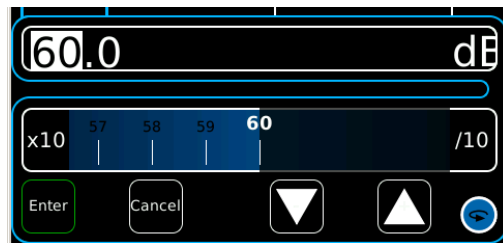

10.2 Drop-down Menus

Drop-down Menus are used to select pre-defined variables. If an opened Drop-down menu extends below the bottom of the visible UI, the menu can be moved up or down on the UI to access menu contents.

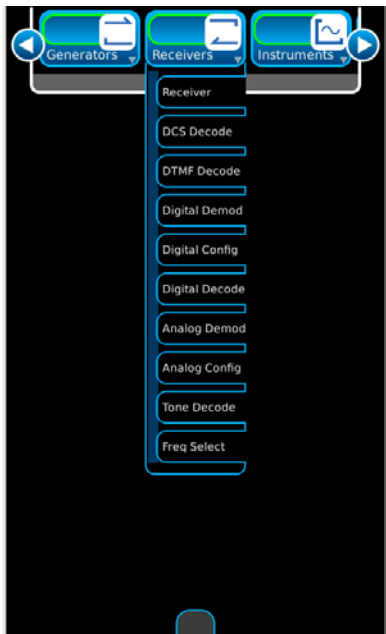

10.3 Keyboard

When a Text Data Field is selected, a keyboard is displayed on the UI which allows the user to enter alpha-numeric content. Data is enabled by pressing the Enter key.



Subject to Export Control, see Cover Page for details.

11.0 SUSPEND (SLEEP) MODE

Use the following steps to place the 3550 / 3550R into suspend (sleep) mode:

STEP PROCEDURE

1. With the 3550 / 3550R running in “active (awake)” mode (SYS Indicator is White), press the HOME Key to display the System Menu.
2. Press the Suspend Button on the System Menu to place the 3550 / 3550R into “suspend (sleep)” mode (SYS Indicator is Blue).

The Touch Screen Display is blank and the internal RF hardware systems are shut OFF.

NOTE

The Digital Hardware systems retain active status and no information or screen settings are lost in “suspend (sleep)” mode.

3. When the 3550 / 3550R is in “suspend (sleep)” mode, press the HOME Key once to display the current time and battery life remaining. Press the HOME Key a second time to restore the system to “active (awake)” mode.

SYS Indicator HOME Key



Subject to Export Control, see Cover Page for details.

12.0 SYSTEM MENU

Press the HOME Key to display the System Menu.

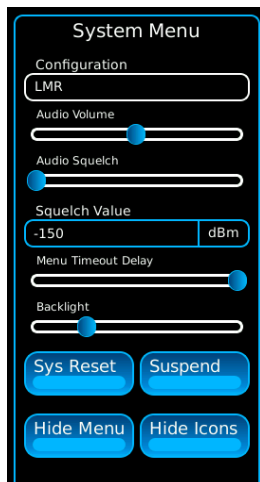

Configuration

Selects different systems.

Audio Volume

Volume control for speaker and headphones.

Audio Squelch

Adjusts Audio Squelch level.

Squelch Value

Selects Audio Squelch level display.

Menu Timeout Delay

Adjust for timeout on Launch Bar for Menu to remain displayed.

Backlight

Adjust for Backlight brightness.

System Reset

Resets Test Set to factory settings.

Suspend

Select to place Test Set in Suspend (Sleep) Mode.

Hide Menu

Launch Bar is not displayed on top of Touch Screen.

Hide Icons

Icons are not displayed on bottom of Touch Screen.

Subject to Export Control, see Cover Page for details.

13.0 CONFIGURATION MODES

The Digital Radio Test System offers two configuration modes depending on the options purchased with the system.

13.1 LMR Configuration

The LMR configuration is the standard mode and offers access to analog, digital, and cable/antenna sweep testing. Analog tests include CW, AM, FM, DTMF, DCS, Two Tone Sequential, Tone Remote and Tone Sequential. Digital tests include P25 Phase 1, DMR, NXDN, dPMR and ARIB-T98.

13.2 PTC Configuration

PTC (Positive Train Control) testing is located under the PTC configuration.

13.3 Verifying Configuration

Press the Home Key to display the System Menu. The Configuration field displays the current configuration mode of the Unit.

13.4 Selecting Configuration Modes

Press the Home Key to display the System Menu. Select the Configuration field to display a selection menu of configuration modes (LMR or PTC). Select the desired configuration mode to change the configuration mode of the Unit.

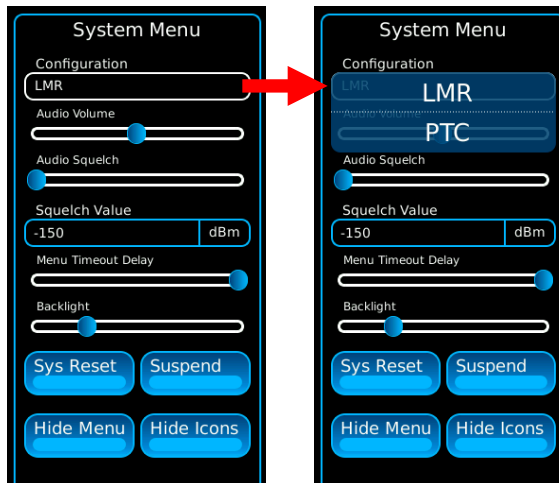

14.0 SCREEN HIERARCHY

The screens available on the 3550 / 3550R are as follows:

(LMR)



(PTC)

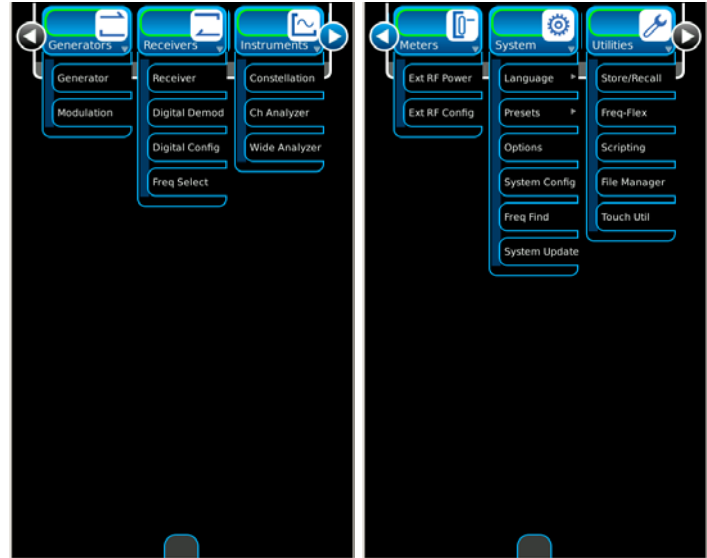

(Optional Functions are shown for display purposes only.)

Subject to Export Control, see Cover Page for details.

15.0 BATTERY/FUSE REPLACEMENT

15.1 Battery

Use the following steps to replace the Battery:

<u>STEP</u>	<u>PROCEDURE</u>
1.	Verify the 3550 / 3550R is OFF and not connected to AC power.
2.	Fully loosen two captive screws in each of the two lower bumpers and remove the bumpers.
3.	Fully loosen five captive screws and lift the Battery Cover from the Case Assembly.
4.	Disconnect the wire harness connecting the battery to the Test Set and remove the battery.
5.	Install new battery and reconnect the wire harness.
6.	Install the Battery Cover on the Case Assembly and tighten the five captive screws (8 in/lbs.).
7.	Install the two lower bumpers and tighten the two captive screws in each bumper (8 in/lbs.).

15.2 Fuse

Use the following steps to replace the Fuse:

<u>STEP</u>	<u>PROCEDURE</u>
1.	Verify the 3550 / 3550R is OFF and not connected to AC power.
2.	Fully loosen two captive screws in each of the two lower bumpers and remove the bumpers.
3.	Fully loosen five captive screws and lift the Battery Cover from the Case Assembly.
4.	Replace fuse.
5.	Install the Battery Cover on the Case Assembly and tighten the five captive screws (8 in/lbs.).
6.	Install the two lower bumpers and tighten the two captive screws in each bumper (8 in/lbs.).

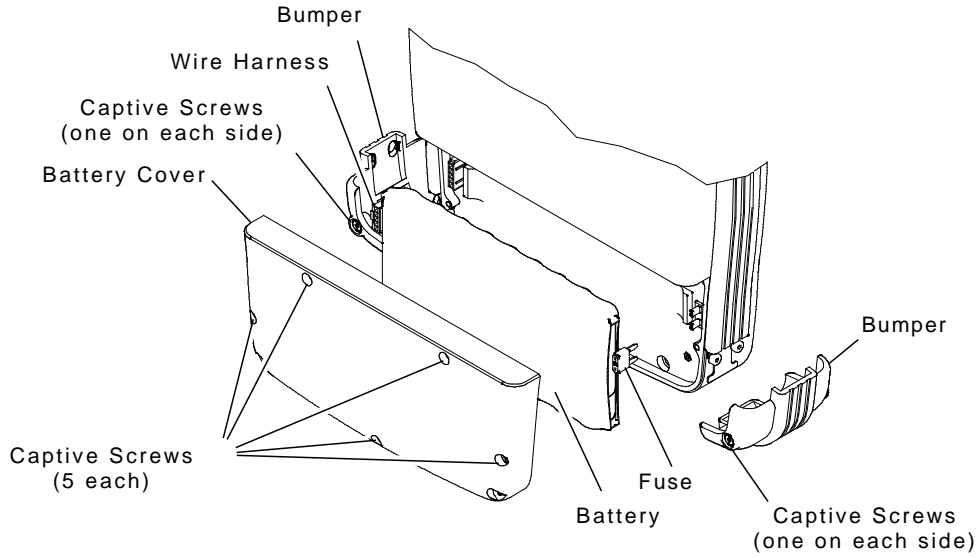

Subject to Export Control, see Cover Page for details.

THIS PAGE INTENTIONALLY LEFT BLANK.



90521 Rev. J0



Feb 2020

English

VIAVI Solutions, Inc.

North America: 1.844.GO VIAVI / 1.844.468.4284

Latin America +52 55 5543 6644

EMEA +49 7121 862273

APAC +1 512 201 6534

All Other Regions: [viavisolutions.com/contacts](https://www.viavisolutions.com/contacts)